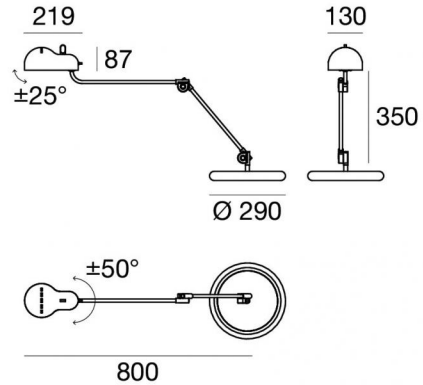



Table Lamps | 220-240 V | 1xE27
9080



Technical data	
Construction year	2021
Type	Table Lamps
Installation position	Floor
Installation environment	Indoor
Lamp cap	1 x E27
Light emission direction	downward
Frequency	50-60 Hz
Optics	Diffused
Safety class	2
IP	IP20
Glow wire test	650°
Direct mounting on normally flammable surfaces	Yes
CE	Yes
Dimmable article	No
Directional	No
Tilting	Yes
total angle (horizontal plane)	100 °
total angle (vertical plane)	50 °
Walk-over	No
Drive-over	No
Cable included	Yes
Electric socket	Type C
Cable length	2.5 m
Resin potting	No
Net weight	6.200 Kg

Finishing casing	
Material	metal
Colour	chrome
Processing	Electroplating
Finishing base	
Material	PE
Colour	black
Processing	Satin finishing



Table Lamps | 220-240 V | 1xE27 9080

Single emission table lamps for indoor application. LED lamplamp included, lamp cap 1xE27.

The device body is made of metal and features a chrome finish, processed by means of electroplating. The ingress protection degree is IP20; the total weight is of 6.200 kg.

. The power supply cable is included and features a 2.5 m length.

The device features protection class II and can be floor-mounted.

Compliant with the EN 60598-1 standard and its specific provisions.

Energy efficiency class

This product contains a light source of energy efficiency class E.

Illuminotechnical Features

Source lumens	806 lm
---------------	--------

Colour temperature	2700 K
--------------------	--------

Colour rendering index	80 Ra
------------------------	-------

Junction temperature (lighting fixture)	80
---	----

Standard Operating Ambient Temperature	25°C
--	------